

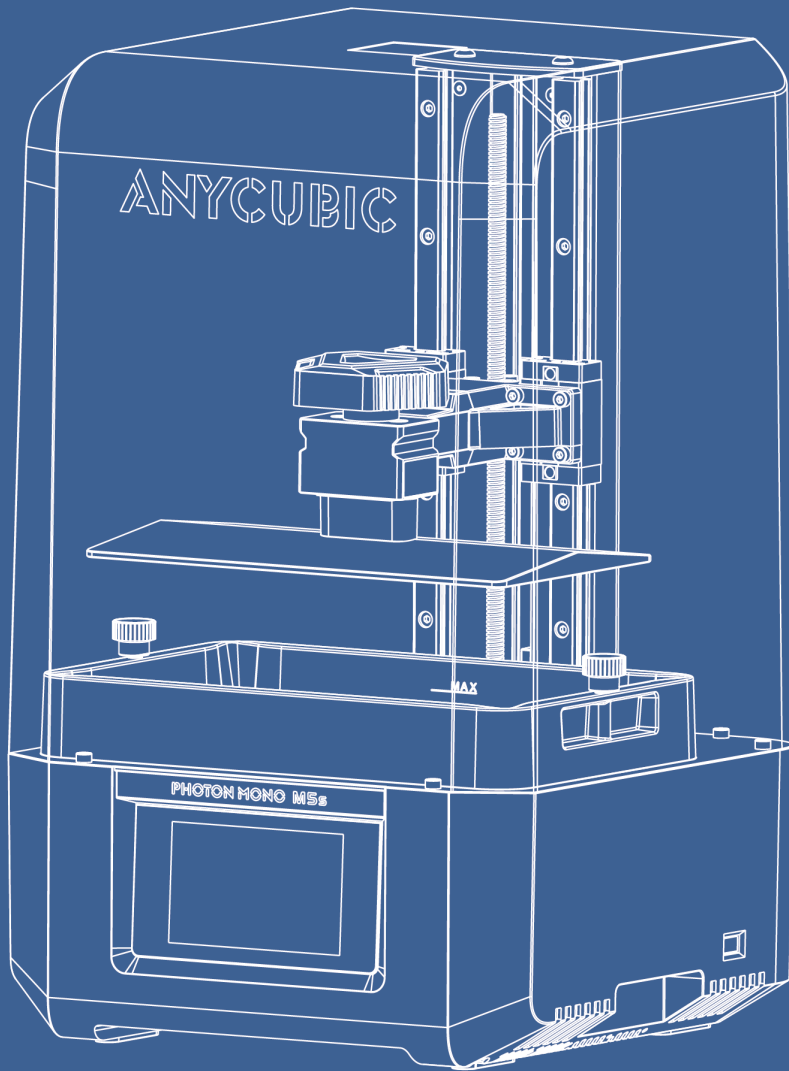

ANYCUBIC



Photon Mono M5s

 User Manual

Dear customer,

Thank you for choosing Anycubic products.

Maybe you are familiar with 3D printing technology or have purchased Anycubic printers before. However, we still highly recommend you read this manual carefully, as the installation techniques and precautions can help you avoid any unnecessary damage or frustration.

Please visit <https://support.anycubic.com> to contact us if you have any questions. You can also learn more information from the website, such as software, videos, models.



Anycubic support center

Copyrighted by "Shenzhen Anycubic Technology Co., Ltd ", all rights reserved.

Team Anycubic

Safety Instructions

Always follow the safety instructions during assembly and usage, to avoid unnecessary damage to the 3D printer or individual injury.



Please contact our Customer Service if you have any issues after receiving the products.



Be cautious when using the scraper. Never direct the scraper towards your hands.



In case of emergency, please immediately cut off the power of the 3D printer and contact our technical support.



Anycubic 3D printer includes components that can cause injury.



Keep the Anycubic 3D printer and its accessories out of the reach of children.



Vapors or fumes may be irritating at operating temperatures. Always use the Anycubic 3D printer in an open and well ventilated area.



Do not expose Anycubic 3D printer to any water or rain environment.



Use Anycubic 3D printer in an environment with a temperature of 8°C-40°C and a humidity of 20%-50%. For optimal performance, do not exceed this range. Also, avoid direct sunlight exposure.



Do not disassemble Anycubic 3D printer, please contact technical support if you have any questions.



Contents

1. Product Overview	5
2. In the Box	6
3. Technical Specification	7
4. Recommended Print Parameters	8
5. Menu Directory	9
6. Preparations	13
7. File Upload	16
8. Print Test	23
9. Resin Exposure Range Finder	26
10. FAQ	28
11. Machine Maintenance	29

Product Overview

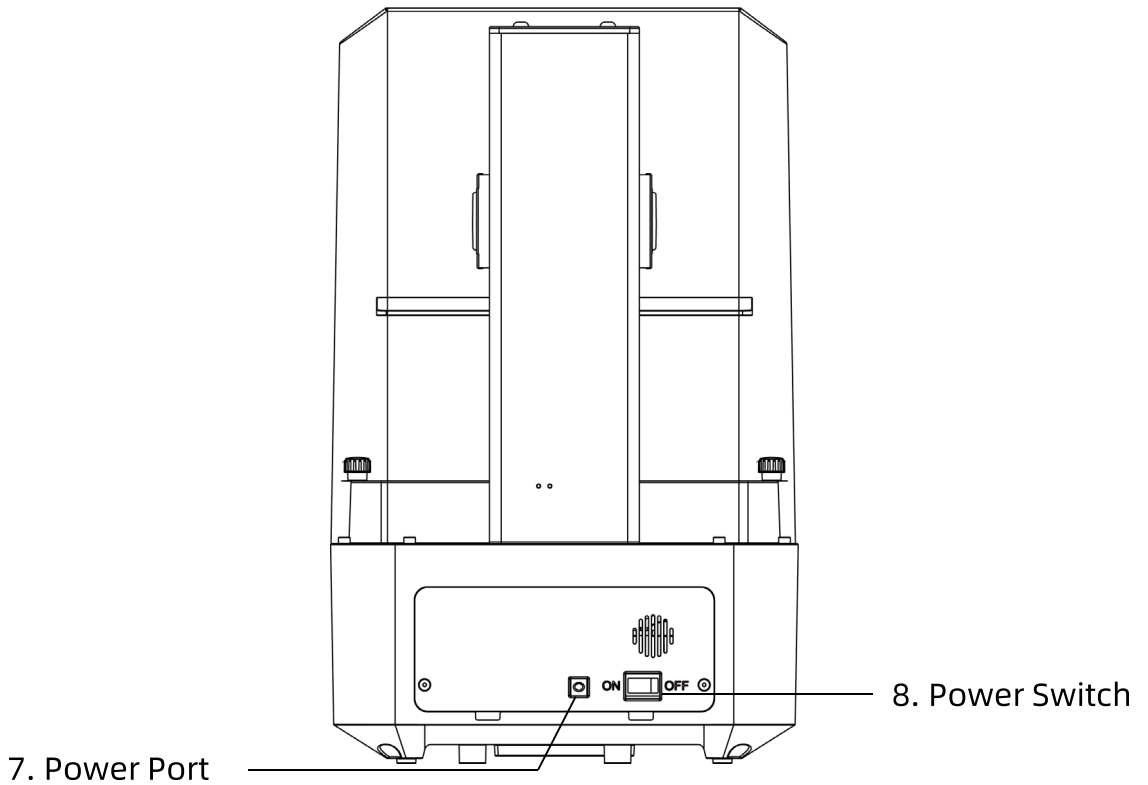
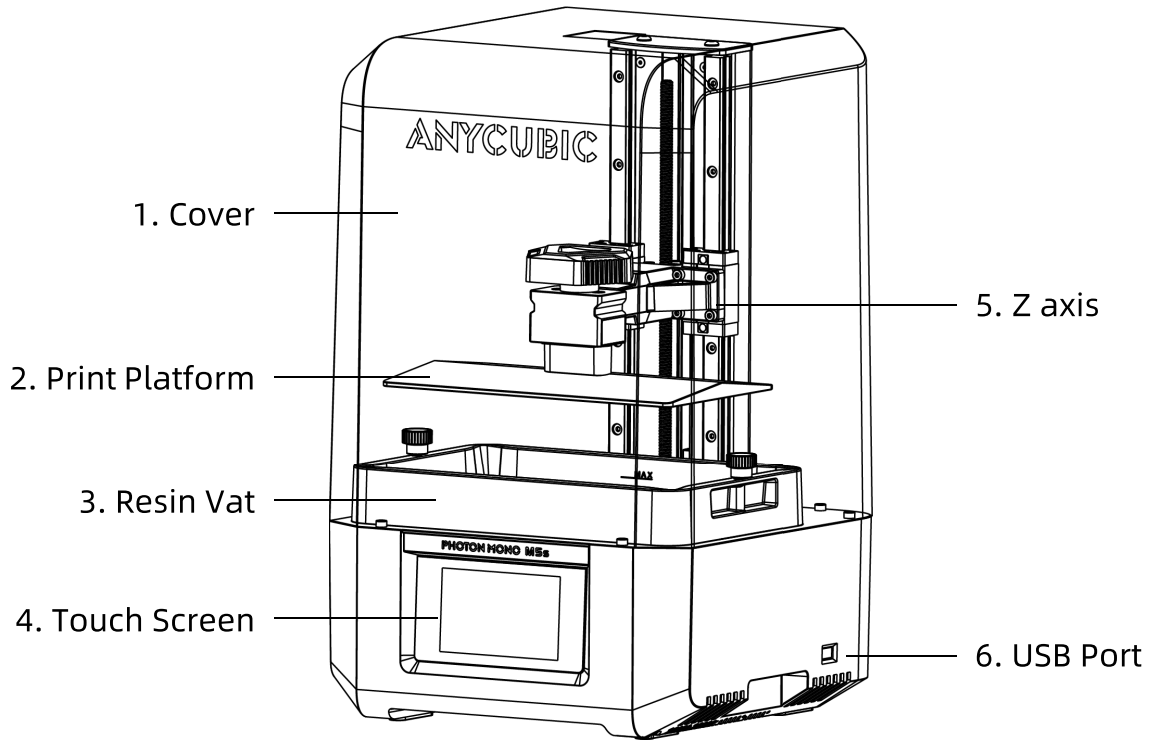

In the Box

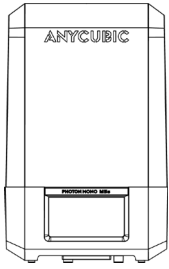

Photon Mono M5s

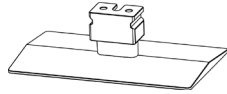

Print platform * 1

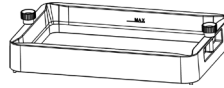

Resin vat * 1



Hex key set



USB drive * 1

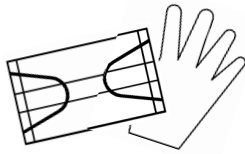

Protective equipment

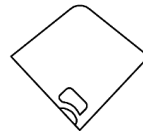

Funnel*5

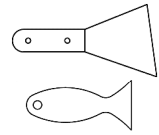

Scraper * 2

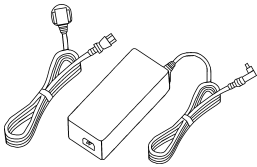

Power cord
Power adaptor

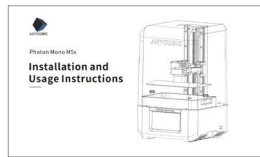

Manual * 1



Screen protector kit

Operating System

System	Photon Mono M5s
Touch Screen	4.3-inch Resistive Screen
Software	Anycubic Photon Workshop (also compatible with other software)
Connectivity	USB Drive, WIFI

Specifications

LCD screen	10.1 inch 12K
Light source	Matrix LED light
XY Resolution	11520 * 5120
Z axis Accuracy	0.01 mm
Suggested Layer Thickness	0.01 ~ 0.15 mm

Physical Dimensions

Dimension	290 mm(L) *270 mm(W) *460 mm(H)
Build volume	218.88 mm(L) *122.88 mm(W) *200 mm(H)
Weight	8.9 kg

WiFi

Frequency Range	2.4 G (2.400~2.4835 GHz)
Work Mode	AP, STA, AP+STA mode

Recommended Print Parameters

Parameters Group	① Default Resin_Normal	② Default Resin_Fast	③ High Speed Resin
Layer Thickness	0.05 mm	0.1 mm	0.1 mm
Normal Exposure Time	2.8 s	3.2 s	1.7 s
Off Time	0.5 s		
Bottom Exposure Time	25 s		10 s
Bottom Layers	5	4	3
Z Lift Distance	8 mm	5 mm	3 mm
Z Lift Speed	6 mm/s	20 mm/s	
Z Retract Speed	6 mm/s	20 mm/s	
Anti-alias	0		
Notice	<p>1.If the print object needs high accuracy, please use group ① and modify the anti-alias level as 16 and the image blur as 3.</p> <p>2. The group ②③ can significantly increase the print speed by cases test. To ensure the print success and print speed, do not modify the parameters casually.</p> <p>3. The group ②③ apply to the model whose hollowed thickness is no more than 2mm.</p> <p>4. The group ②③ must work with the 3rd Gen High-speed release film this printer provided to avoid print failure. The film can be used to print 30000 layers.</p> <p>5. Refer to 16-18 pages for the instructions of parameter groups.</p>		

--The data above root in Anycubic lab, only for reference.

Menu Directory

Home menu

Print

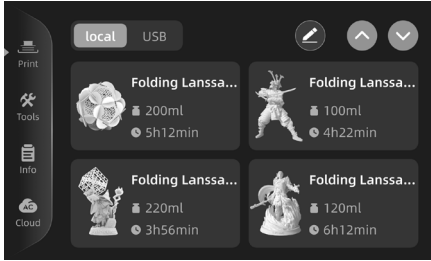

Tools

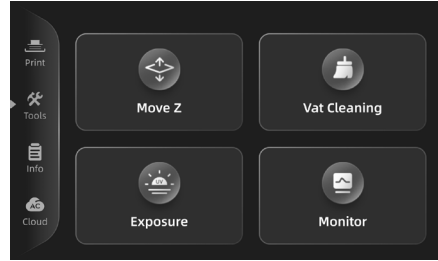

Information

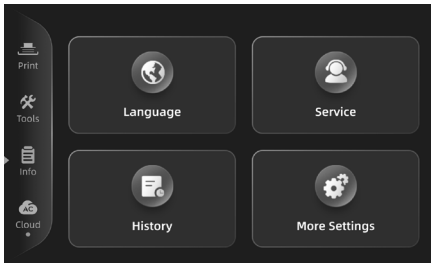

Cloud



Print

Print:

Switch to local/
USB drive file list

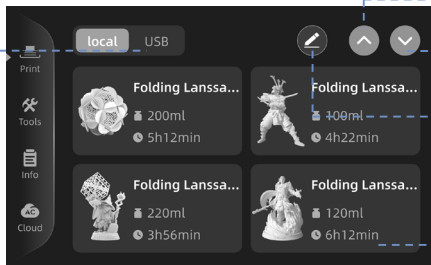

Page up

Page down

Edit files

Enter into the file details

File Details:

Switch to intelligent/
expert mode settings

Functions setting

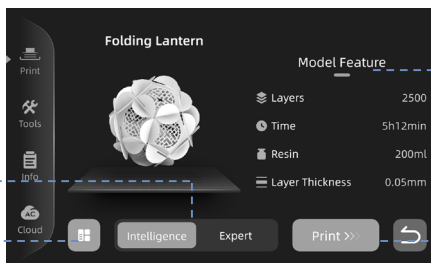

Print job information

Start the printing

Menu Directory

Tools

Move Z:

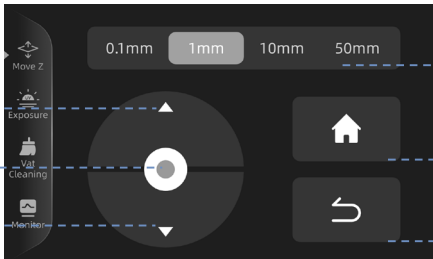

The screenshot shows the 'Move Z' menu with a vertical sidebar on the left containing icons for 'Move Z', 'Exposure', 'Vat Cleaning', and 'Monitor'. The main area has four buttons at the top: '0.1mm', '1mm', '10mm', and '50mm'. In the center is a circular directional pad with up, down, left, and right arrows. To the right of the pad are two buttons: a home icon and a back arrow icon.

Move the Z axis upwards

Stop moving the Z axis

Move the Z axis downwards

Move Z by 0.1mm /1mm/10mm/50mm

Return to Zero

Return to the Tools Menu

Exposure :

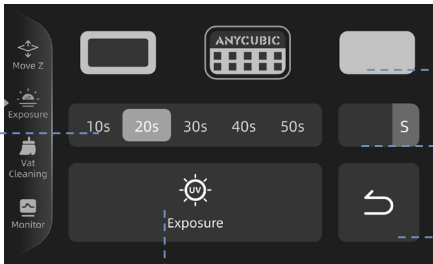

The screenshot shows the 'Exposure' menu. The sidebar on the left has icons for 'Move Z', 'Exposure', 'Vat Cleaning', and 'Monitor'. The main area features a top row with three image selection buttons, the first of which is labeled 'ANYCUBIC'. Below this is a row of exposure time buttons: '10s', '20s', '30s', '40s', '50s', and a 's' button. At the bottom, there is an 'Exposure' button with a UV light icon and a back arrow button.

Set the exposure time

Choose an image to expose

set the exposure time

Return to the Tools Menu

Start exposure

Vat Cleaning:

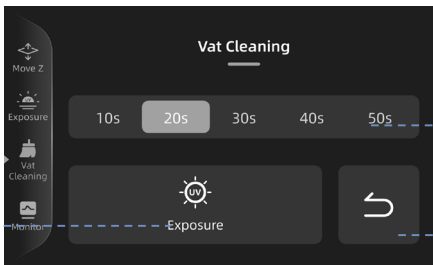

The screenshot shows the 'Vat Cleaning' menu. The sidebar on the left has icons for 'Move Z', 'Exposure', 'Vat Cleaning', and 'Monitor'. The main area has a title 'Vat Cleaning' and a row of exposure time buttons: '10s', '20s', '30s', '40s', and '50s'. Below this is an 'Exposure' button with a UV light icon and a back arrow button.

Set the exposure time

Start exposure

Return to Tools Menu

Monitor:

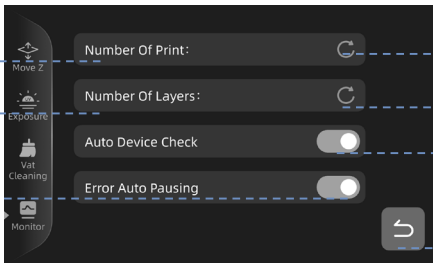

The screenshot shows the 'Monitor' menu. The sidebar on the left has icons for 'Move Z', 'Exposure', 'Vat Cleaning', and 'Monitor'. The main area has four settings: 'Number Of Print:' with a refresh icon, 'Number Of Layers:' with a refresh icon, 'Auto Device Check' with a toggle switch, and 'Error Auto Pausing' with a toggle switch. A back arrow button is at the bottom right.

Statistics of print times

Statistics of print layers

Enable/disable error automatic pause

Reset the print times

Reset the print layers

Enable/disable auto device check

Return to the Tools Menu

Menu Directory

Information

Language:

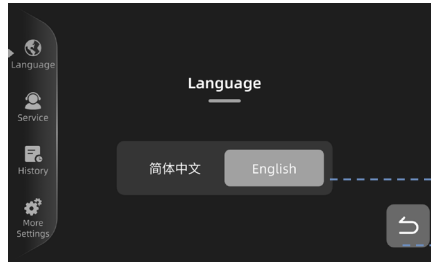

Set the language

Return to the Info Menu

Service:

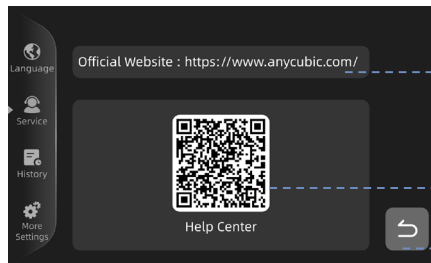

Official website

QR code of support center

Return to the Info Menu

Information:

Print history

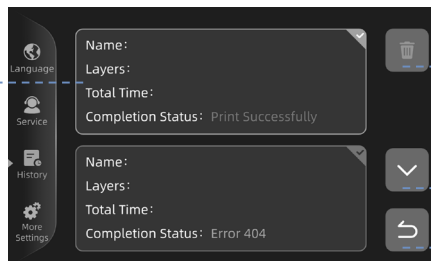

Delete the record

Page down

Return to the Info Menu

More Settings:

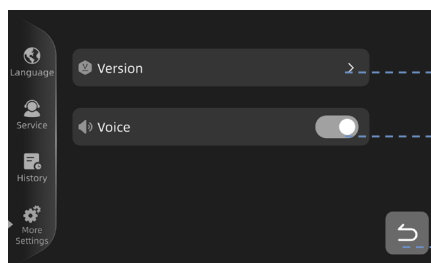

Enter into the version interface

Turn on/off the screen sound

Return to the Info Menu

Menu Directory

Version:

Printer system	System Photon Mono M5		
System version	Version Information		
Serial number	Version Serial Number		Enter into upgrade interface
Printer ID	ID		Return to the More Settings

Upgrade:

Current firmware version	Current		OTA upgrade
Latest firmware version	Latest		USB upgrade
What's new	Optimization		

Cloud

Cloud:

WiFi connection	Networks		WiFi connection status
	Anycubic APP		Reset WiFi status
Printer's hotspot	Printer Hotspot		App connection
	Scan the code to install the app, quickly initiate one-button printing after wifi connection, and check the printing status at any time.		Turn on/ off WiFi module
			Enter into the network settings

Network settings:

Name of the network	WLAN_		
	Server Location	>	Set server
Printer CN	CN		
IP address	IP		QR code of the printer
MAC	Mac		Return to the Cloud

Preparations

1. Turn on the printer and then wait for the auto device check. The printer automatically checks the hardware help you shooting the troubles and reduce the print failure. When there is an error, the printer will pop up the error QR code. Please scan the code and follow the guide.

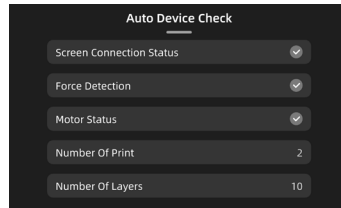

LCD screen connection

Check the connection of LCD screen to avoid the exposure error caused by bad connection.

Force Detection

Check whether the force sensor that affects the resin volume detection and leveling detection works.

Motor connection

Check the connection of motor to ensure it works properly.

If you disable the auto device check, the printer will not automatically check the hardware condition.

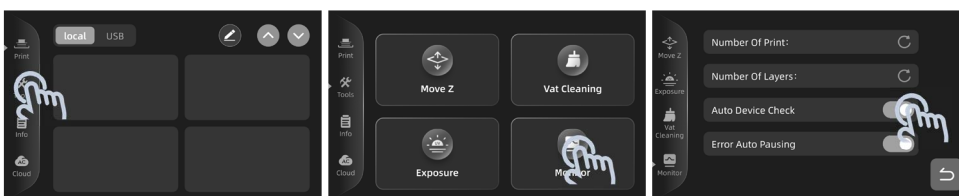

Disable auto device check

2. Raise Z axis by 100mm.

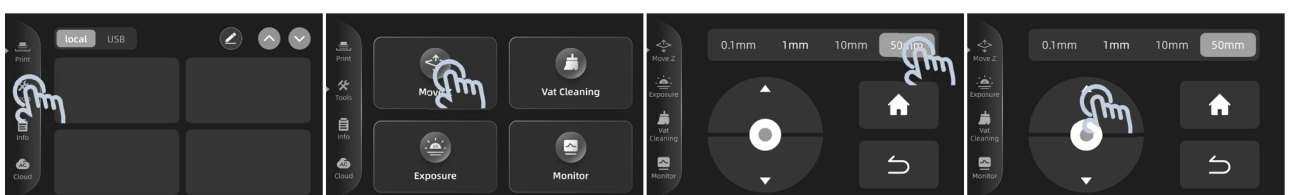

Click 2 times

Preparations

3. Install the screen protector.

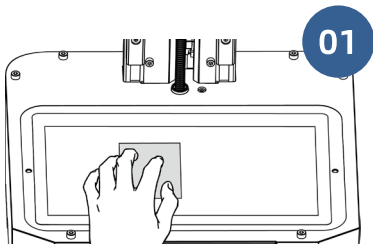

Peel off the protective film
Clean the LCD screen
with tool kit

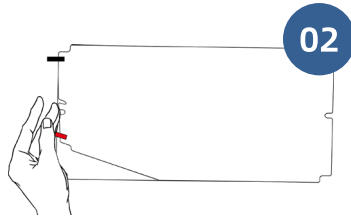

Peel off the film ①

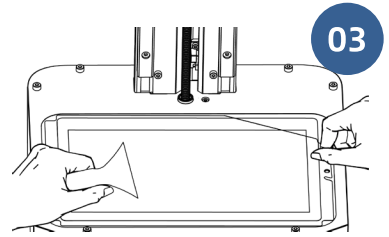

Align the location holes
with screws and squeeze
out the bubbles

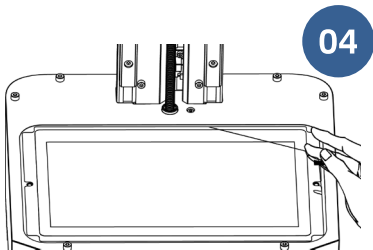

Peel off the film ②

4. Install the print platform.

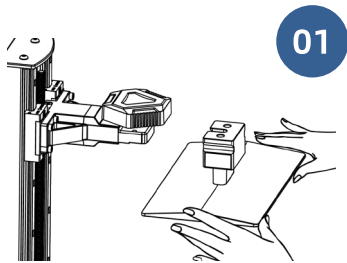

Push the platform onto
the platform carrier

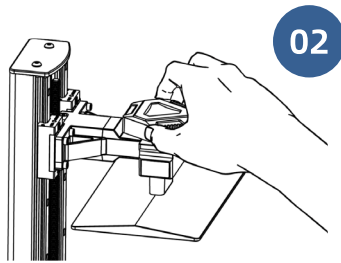

Tighten the knob

5. Choose an exposure image to test.

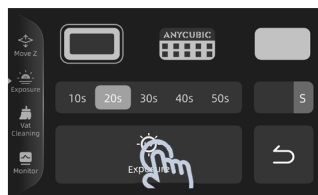
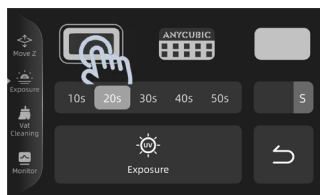
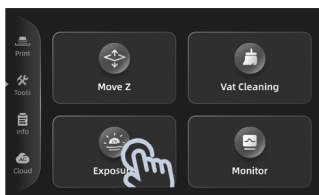

The white part is
exposure area

6. Install the resin vat.

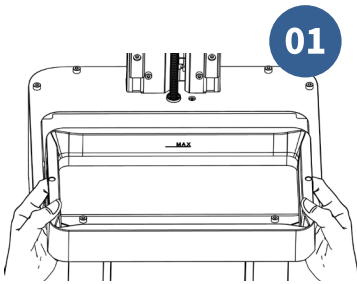

Put the resin vat with its feet
stuck in location holes

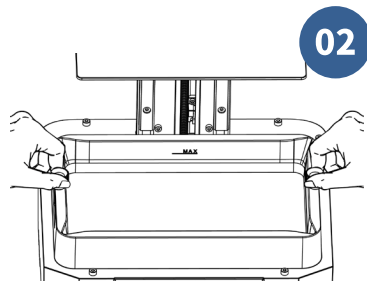

Tighten two knobs

USB

1. Use Anycubic Photon Workshop software to process the 3D model file. The installer and instructions is saved in the USB drive.
2. When you set the parameters in Anycubic Photon Workshop, there are three groups of parameter which can be apply to the print with different needs.

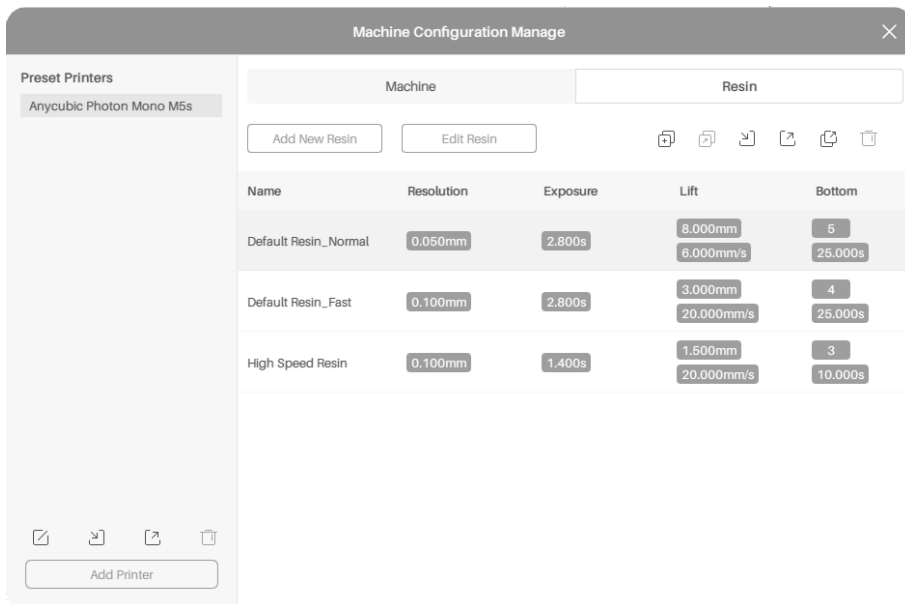

Choose the parameter group according to the personal requirement

① Default Resin_Fast

Apply to the Anycubic resin with fast printing speed. The layer thickness is 0.1mm. It increases the average print speed of the maximum model to 60mm/h by optimizing the Z-axis motion control.

② High Speed Resin

Apply to the Anycubic high speed resin with the fastest printing speed. The layer thickness is 0.1mm. It increases the average print speed of the maximum model to 100mm/h by optimizing the Z-axis motion control.

Notice for using the parameters of Default Resin_Fast & High Speed Resin:

1. The parameters apply to the model whose hollowed thickness is no more than 2mm.
2. The parameters must work with the 3rd Gen High-speed release film this printer provided to avoid print failure. The film can be used to print 30000 layers.

③ Default Resin_Normal

Apply to the Anycubic resin with normal printing speed. Also, the intelligent mode is available for the parameter group.

- **Intelligent mode**

The software can set the normal exposure time through analyzing the model features to increase the success rate of printing and improve the print effect.

The screenshot shows the 'Edit Resin' dialog box with the following settings:

Information			
Resin Name	Default Resin_Normal	Resin Volume(ml)	1000.000
Resin Type	Standard Resin	Resin Price	220.000 \$

Slice Parameter			Intelligent Mode
Layers Thickness(mm)	0.050	Control Type	Basic
Normal Exposure Time(s)	2.800	Z Lift Distance(mm)	8.000
Off Time(s)	0.500	Z Lift Speed(mm/s)	6.000
Bottom Exposure Time(s)	25.000	Z Retract Speed(mm/s)	6.000
Bottom Layers	4		
Anti-alias	16		
Gray Level	0		
Image Blur	2		

OK

- **Expert mode (disable the intelligent mode)**

Set all slice parameters according to the personal requirement.

If the intelligent mode is enabled in slicing (A), the mode can be switched to expert before printing. If the intelligent mode is disabled in slicing (B), the mode cannot be changed.

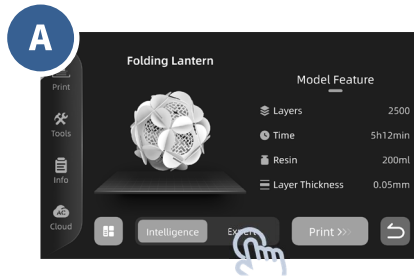

Mode can be changed

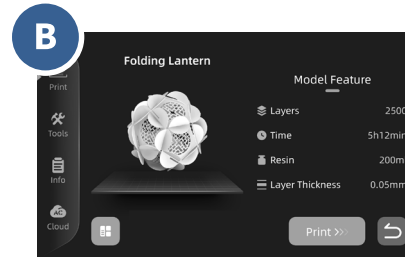

Mode cannot be changed

3. Save the sliced file to USB drive.

4. Then, insert the USB drive to the printer.

Notice for the USB drive:

- ① It is recommended that use the USB drive we provide. If you are using your own USB drive, please ensure that it is formatted to **FAT/FAT 32** and has a memory size of less than **32G**.
- ② To ensure proper file reading, please put print files in the root directory of USB drive.

Cloud

Please connect the printer to Anycubic App first for remote uploading and monitoring.

1. Check whether it is global server. If not, click to switch to the global server and wait for the printer restarting.

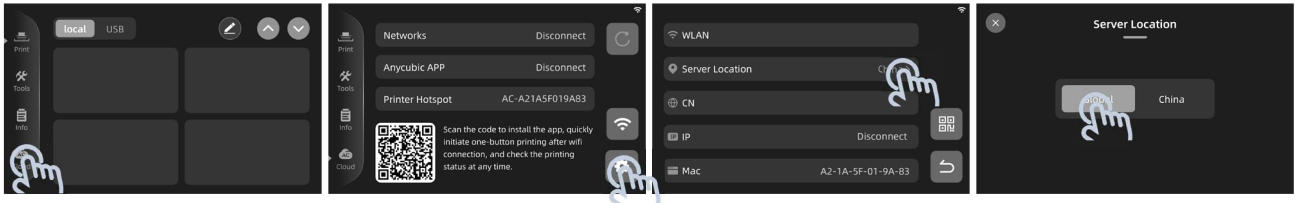

2. Reset WIFI connection.

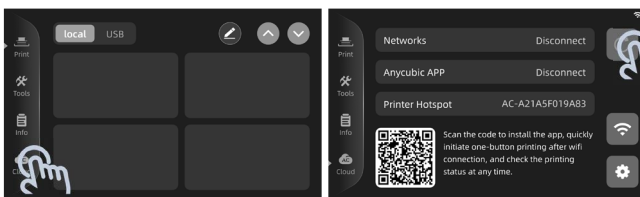

3. Please search "Anycubic" in App Store or Goolge Play, or scan the QR cord on the printer, to download Anycubic App. Then, sign up and sign in.

4. Add a printer in Anycubic App.

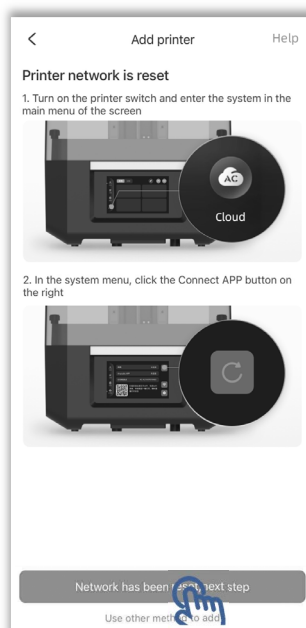
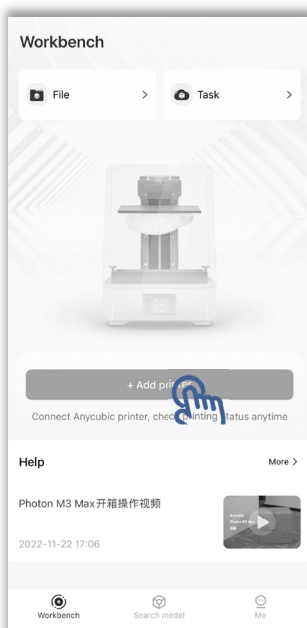

File Upload

5. Connect to printer's hotspot.

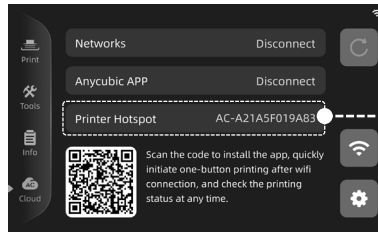
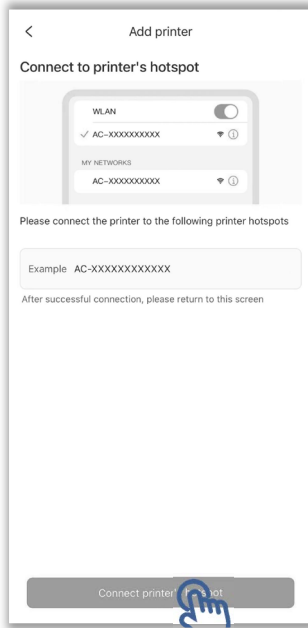

Check the printer's hotspot

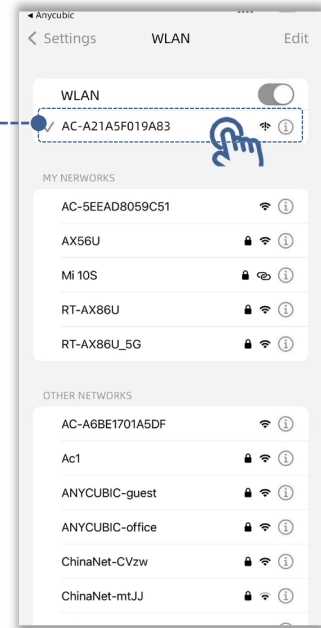

Select the printer's hotspot

6. Return to App, connect the printer to the network.

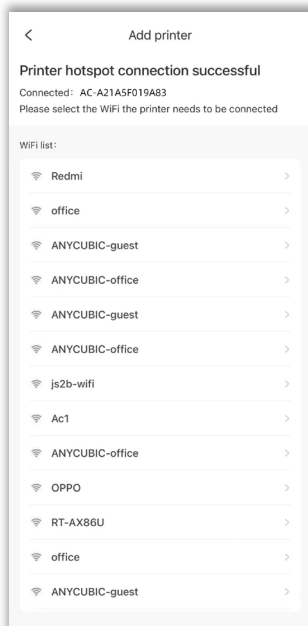

Select WIFI

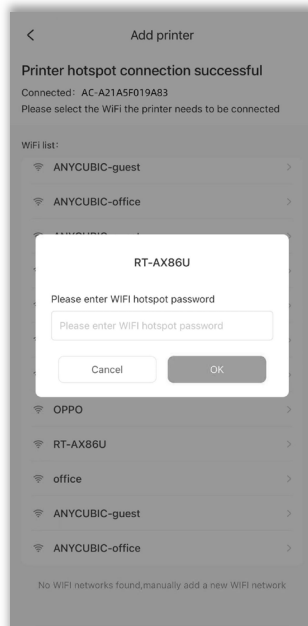

Enter in password

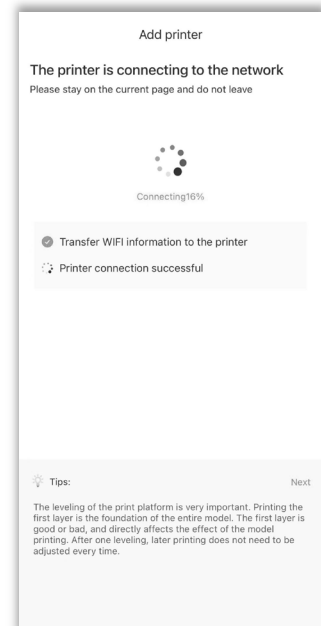

Notice:

- ① The location and local network must be allowed to use during connection.
- ② Please ensure the connection to printer's hotspot during the network connection to avoid connection failure.

7. Printer is added successfully. Search model or upload the model files.



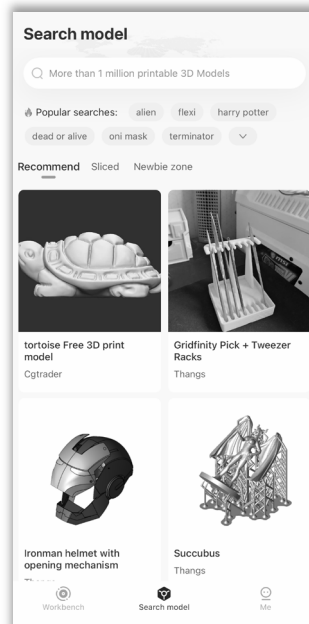
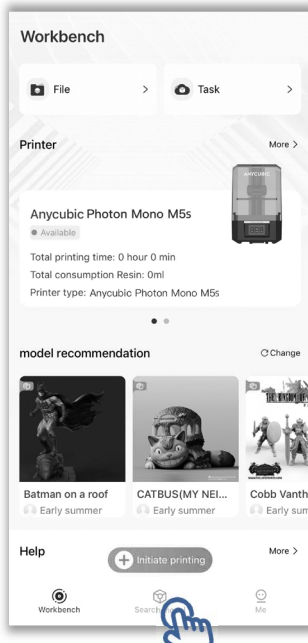

- Search model

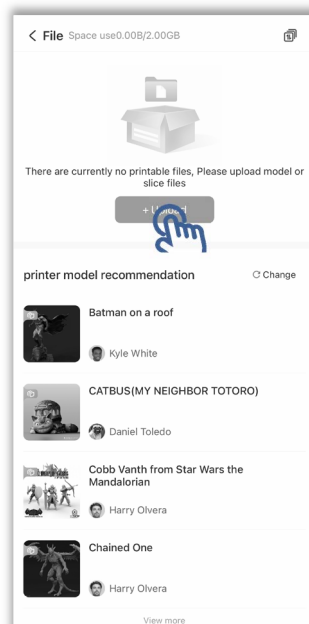
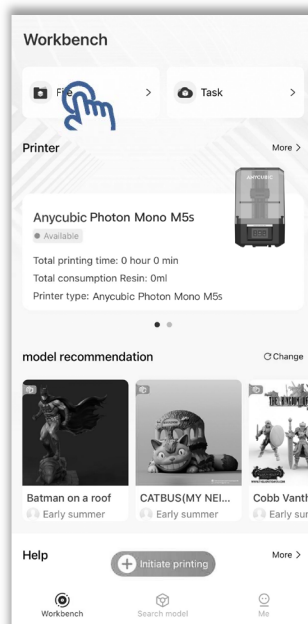

- Upload the model files

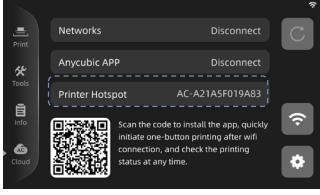

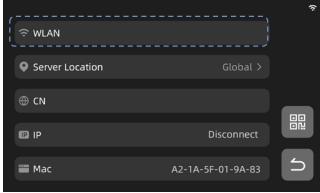
Cloud Connection Troubleshooting

Issues	Troubleshooting	Solution
<p>Fail to connect to printer's hotspot in App</p>	<p>Check whether it is printer's hotspot</p> 	<p>If not, please reconnect to the printer's hotspot.</p>
<p>The printer prompts that WiFi connection failed</p> 	<p>Check whether the WIFI and its password is correct</p>	<p>If not, please click  in Cloud menu on the printer to reset WIFI. Then, connect the printer to network again.</p>
	<p>Check whether WLAN on printer is the WIFI</p> 	<p>If not, please click  in Cloud menu on the printer to reset WIFI. Then, connect the printer to network again.</p>
	<p>Check whether the WIFI network is unavailable</p>	<p>Join an available network. Click  in Cloud menu on the printer to reset WIFI. Then, connect the printer to network again.</p>

Connection Status

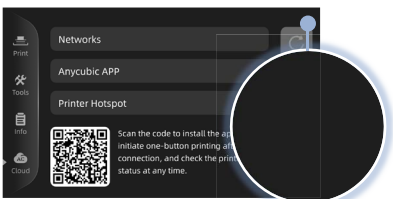

WiFi module off
disconnected



WiFi module on
disconnected



WiFi module on
connected

Print Test

*The release film on the resin vat is consumable. Please pay attention to the status of release film on the touch screen and replace the film timely.

Please check the release film carefully before and after every printing. If the film is broken, replace it immediately to avoid further damage to the machine.

1. Make sure you wear masks and gloves (to avoid direct skin contact with resin), slowly pour resin into the vat with **resin level not exceeding the vat's maximum scale**.

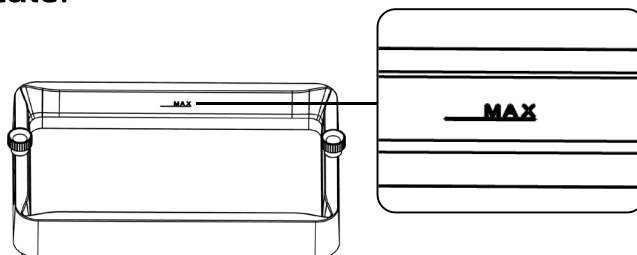

2. Print file.

- USB drive file



- Remote print

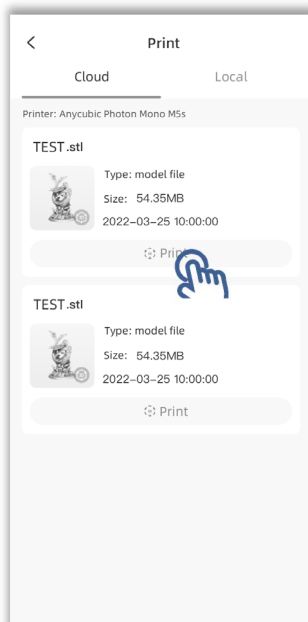
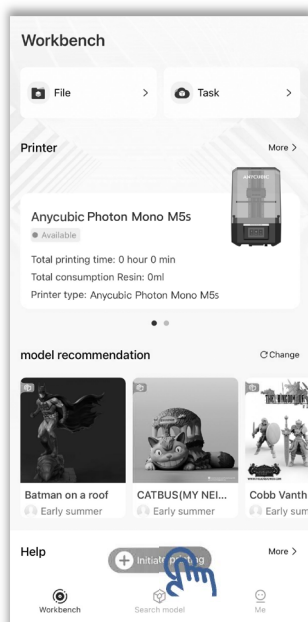

① Before printing, the printer checks the hardware condition, resin volume and leveling before each print job. When there is an error, the printer will pop up the error QR code. Please scan the code and follow the guide.

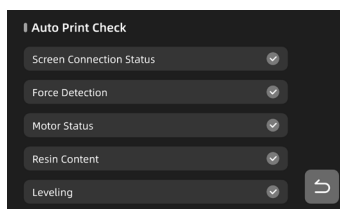

Resin

Check whether the volume of resin in the vat is sufficient to finish the print job. Usually, the required resin volume is a little more than the resin volume estimated by the slice software.

If it prompts that the resin volume is not enough, please add resin and then check it again.

Leveling

Check the leveling to avoid the print failure caused by layer separation or other errors.

② During printing, the printer automatically monitors the conditions which may cause print failure and prompt the error to the customers in case resin is wasted or even damage the printer. When the printer detects an abnormal condition, it will pause the print job automatically and pop up the error report. Please check the sliced file and the model according to the report.

Bottom non-stick detection

It monitors the condition that model does not stick to the print platform.

When the printer detect the model does not stick the platform, please check the bottom exposure time of the file.

Print Test

The resin detection and error auto pause can be disabled and then the printer stops the prompt.

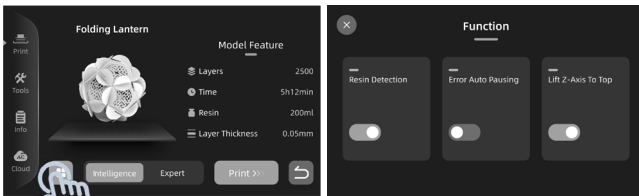

Disable the functions you don't need

3. When the printing is finished, resin may be cured partly in the vat. Please set to Vat Cleaning and remove the residue.

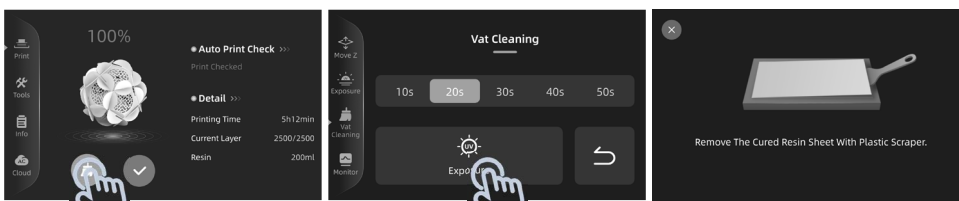

Remove resin sheet by plastic scraper

4. Finishing

- After printing, remove the platform when resin stop dropping from the platform. Remove the model by metal scraper and then wash it with 95% alcohol or other detergent. It may need post-curing to achieve better hardness by being exposed directly to sunlight or a UV-curing machine.
- After printing, there might be some cured resin left in the vat. Please clean the vat timely, and filter the remaining resin by a funnel. Otherwise, it may cause damage to the release film or LCD screen. If you do not use the resin now, it is recommended to store it in an airtight container away from light.

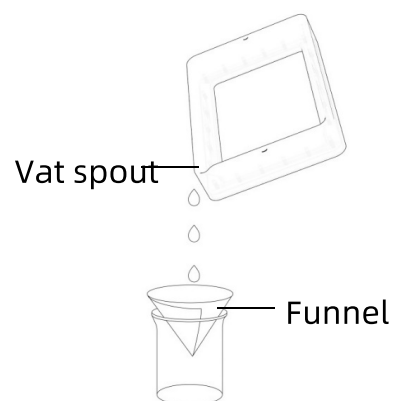
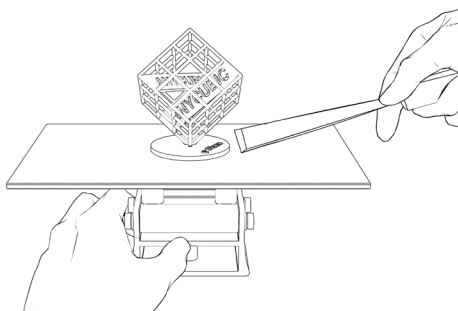

Resin Exposure Range Finder

“R_E_R_F” is an abbreviation for “Resin Exposure Range Finder”. This function is used to find out the optimal exposure parameters for different resins.

1. Import the R_E_R_F file which is saved on USB drive into the slicing software. There are eight models in the file. The exposure time for model 1 is equal to "normal exposure time (s)" of the file, and the exposure time for other models will be increased by an increment of **0.25 s**.

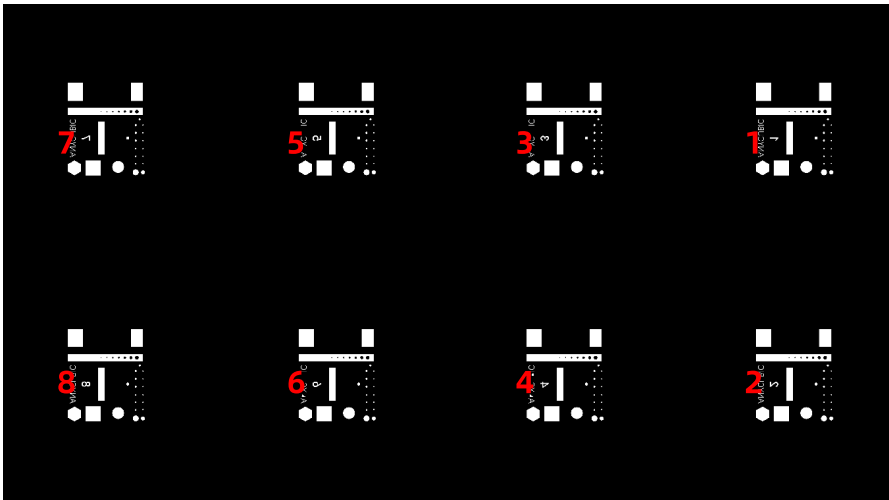

The numbers on the models indicate their order

2. According to the personal requirement, adjust the exposure time of the models by modifying "normal exposure time (s)" of the file. When exposure time for Model No. 1 is changed, the exposure time for other models will be increased by an increment of **0.25 s**.

For example, when normal exposure time is set to 1.5 s, the exposure time for Model No.1-8 is: 1.5 / 1.75 / 2 / 2.25 / 2.5 / 2.75 / 3 / 3.25 s.

3. After printing, remove and clean the models. Compare the print effect of models and choose the model's exposure time that meets your needs as the print parameter. Take a comparison of model A&B as an example.

Resin Exposure Range Finder

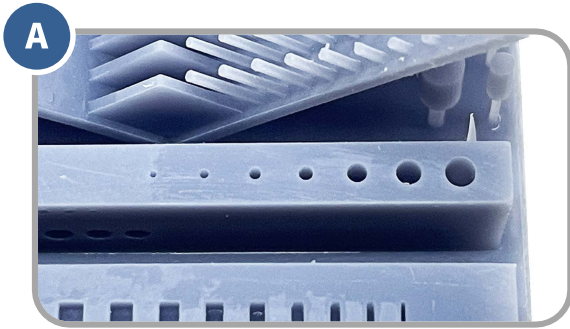

More holes

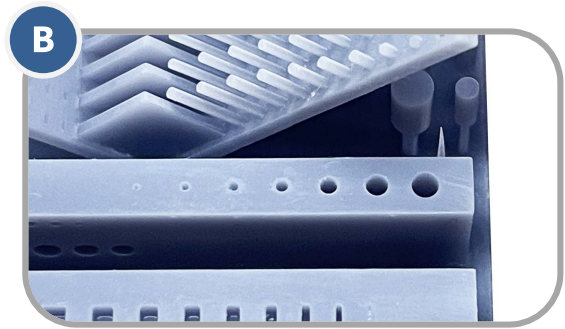

Less holes

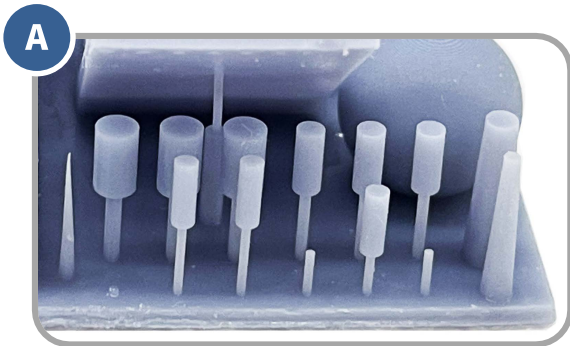

Less cylinder

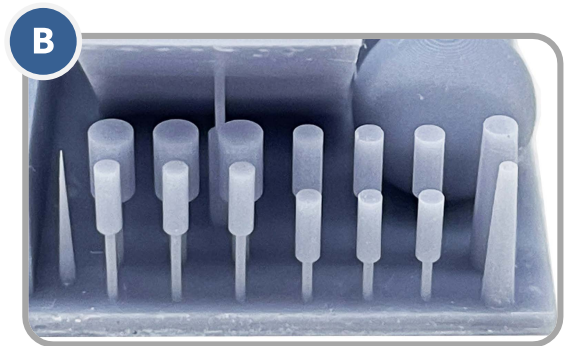

More cylinder

- Model A has more holes and fewer cylinder. If you print by the parameter of model A, more details of model can be printed with high risk of failure.
- Model B has fewer holes and more cylinder. If you print by the parameter of model B, model may be printed successfully yet with some details lost.

In addition, you can compare the bridges, needles or other parts to choose a proper model and find the parameter. If none of them can be chose, adjusting the "normal exposure time (s)" is suggested.

Notice: DO NOT change the file name of "R_E_R_F", because Anycubic 3D printer can only recognize THIS file name to run this function. Also, do not name other file as "R_E_R_F".

Model do not stick to platform

- Bottom exposure time is insufficient. Please increase the exposure time.
- Contact area between the model and platform is small. Please add a raft.

Layer separation or splitting

- The machine is not stable during printing.
- The release film is not tight enough or needs a replacement.
- The printing platform or resin vat is not tightened.
- The lift speed is too fast.
- The model is hollowed without punching.

Layer shift

- Add supports.
- Reduce the lift speed.

Floccules left in resin vat or attached to models

- The exposure time is too long. Reduce the normal exposure time and bottom exposure time.

Resin Vat Maintenance

- **Remove the cured resin from release film:** Set Vat Cleaning and then remove the cured resin sheet to protect the film. Do not use sharp objects to scrape off the residues on the film.

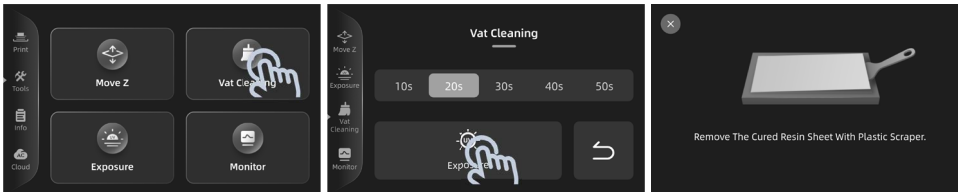

Remove resin sheet by plastic scraper

- **Release film replacement:** The statistics of print times and print layers are shown in Monitor interface. Please check them and replace release film timely to avoid print failure or even the damage to printer.



Replace release film at this time

Click reset button after replacement

- If you do not use the resin for over two days, store it in an airtight container away from light.

Firmware Upgrade

Check whether the current firmware needs update. "Optimization" shows what's new in the latest firmware.

- **USB upgrade:** Visit the official website to download the installer and save it to a USB drive. Then, insert the USB drive to printer to upgrade.
- **OTA upgrade:** If the network is connected, directly upgrade by OTA.

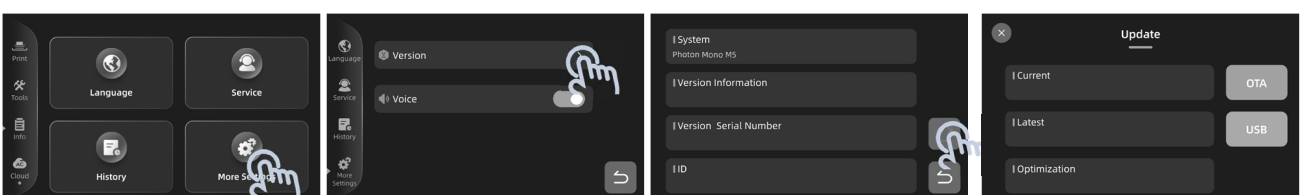

OTA / USB upgrade

Z-axis Maintenance

If Z axis makes a noisy sound, please apply lubricant to Z lead screw.

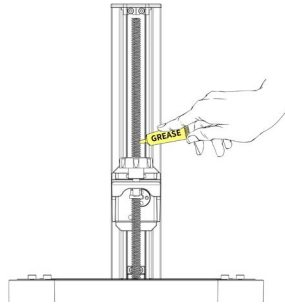

Cleaning

- **Clean the print platform:** Clean platform with alcohol and paper towel.
- **Protect LCD screen :** If the resin cured on screen protector, please replace it immediately to protect LCD screen.
- **Clean the body of printer:** Clean the body of the printer with alcohol.

Thank you for purchasing Anycubic products! Under normal usage and service, the products have a warranty period of up to one year. Please visit Anycubic support center(support.anycubic.com/en) to report any issues with Anycubic products. Our professional after-sale service team would respond within 24 hours and solve the issues.